



POWER FROM WITHIN

# GC315-GC400 CONTROLLER

**SMARTTECH**  
A DIVISION OF MECC ALTE

USER MANUAL



## Table of Contents

<b>1</b>	<b>Safety information</b> .....	<b>4</b>
<b>2</b>	<b>Information concerning disposal</b> .....	<b>4</b>
<b>3</b>	<b>Forward</b> .....	<b>5</b>
<b>4</b>	<b>Definitions</b> .....	<b>5</b>
<b>5</b>	<b>Main functions</b> .....	<b>6</b>
5.1	Front Panel GC315 <sup>Mains</sup> , GC315 <sup>Plus</sup> and GC315 <sup>Link</sup> .....	6
5.2	Front Panel GC400 <sup>Mains</sup> , GC400 <sup>Mains+Link</sup> .....	7
5.3	Buttons (ref. to fig. 1, 2, 3) .....	8
5.4	Indicators (ref. to fig. 1) .....	11
5.5	Multifunctional display .....	13
5.5.1	LCD lighting .....	13
5.5.2	Contrast adjustment .....	13
5.5.3	Mode navigation (ref. to fig. 2) .....	14
5.5.4	Display area layout (ref. to fig. 3) .....	15
5.5.5	Top status bar (ref. to fig. 4) .....	15
5.6	Display mode .....	16
5.6.1	Programming (P.xx) .....	16
5.6.2	Status information(S.xx) .....	19
5.6.3	Electrical measurements(M.xx) .....	21
5.6.4	Engine measurements (E.xx) .....	23
5.6.5	PMCBus .....	23
5.6.6	History logs(H.xx) .....	24
<b>6</b>	<b>Operating principles</b> .....	<b>24</b>
6.1	GC315, GC315 <sup>Plus</sup> , GC315 <sup>Link</sup> .....	24
6.1.1	Off/Reset .....	25
6.1.2	Manual .....	25
6.1.3	Automatic .....	26
6.1.4	Test .....	27
6.2	GC400x .....	28
6.2.1	SSB + SSTP Plants - GC400 <sup>Mains</sup> / GC400 <sup>Mains+Link</sup> .....	28
6.2.2	MPM Plants - GC400 and GC400 <sup>Link</sup> .....	30
<b>7</b>	<b>Special setting</b> .....	<b>32</b>
7.1	Selecting the language .....	32
7.2	Date/Time setting .....	32
<b>8</b>	<b>Fuel pump (if present on the system)</b> .....	<b>33</b>
8.1	Select function .....	33

## INTRODUCTION

The manual must always be kept in a safe place where it is readily available for quick reference.

The manual should be read carefully, and every paragraph understood by the operators and technicians doing routine and periodic maintenance.

If the manual is lost or damaged, ask the installer/manufacturer for a copy, quoting the model, code, serial number and year of manufacture.

## 1 Safety information

Many accidents are caused by poor knowledge and the non-observance of safety regulations, which must be observed when operating and/or servicing the machine.

To prevent accidents, before using or servicing the machine you should read, understand and observe the precautions and warnings in this manual.

The following indications have been used to identify the safety messages in this manual:

 **WARNING!** This indication is used in the safety messages for risks which, unless avoided, can cause malfunction or damage to property or persons.

 **INFORMATION!** This term implies the message provides information useful for performing the current operation, or explanations or clarifications for procedures.

## 2 Information concerning disposal

 **INFORMATION!** on the disposal of old electrical and electronic equipment (applicable in European countries that have adopted separate waste collection systems).



Products bearing the barred wheeled waste container symbol cannot be disposed of with normal urban waste. Old electrical and electronic equipment should be recycled in a facility authorized to process these items and dispose of the components. Contact your local authority for information on where and how to deliver such products to the authorized site nearest you. Proper recycling and disposal helps conserve resources and prevents detrimental effects for health and the environment.

### 3 Forward

This manual describes the controllers **GC315**, **GC315<sup>Plus</sup>**, **GC315<sup>Link</sup>**, **GC400**, **GC400<sup>Link</sup>**, **GC400<sup>Mains</sup>** and **GC400<sup>Mains+Link</sup>**.

Throughout this document, GC315x will refer to all controllers of the GC315 series and GC400x will refer to all controllers of the GC400 series, while the names GC315, GC315<sup>Plus</sup>, GC400, etc. will refer to a specific controller and the names GC315/GC315<sup>Plus</sup> or GC400<sup>Mains</sup>/GC400<sup>Mains+Link</sup> will refer to a group of controllers.

### 4 Definitions

**LOCKOUT** - is used to indicate a fault that prevents the generator from operating and causes automatic and immediate emergency engine shut-down.

**POWER-OFF** - is used to indicate a fault that prevents the generator from operating and causes the standard automatic engine shutoff (including a cooling phase).

**WARNING** - is used to indicate a fault that requires the intervention of the operator without engine shutoff.

**MAINS** – Public power supply line.

**LOAD/BUS** – Electrical power supply line of the loads. It can be connected to more gensets

**GENERATOR** – Electricity line that is connected to the alternator of the Generator set

**LOAD** – Electrical power supply line of the loads. This can be connected to the **Mains** or to the **Generator**

**MCB** - Switch or component to manage the switching between the **Mains** line and the **Load** line.

**GCB** – Switch or component to manage the switching between the **Generator** line and the **Load** line.

**CANBUS** - Interface for the control and diagnostics of engines equipped with SAE J1939 or CanBus MTU interface.

**ISLAND** - Type of plant where one or more gensets supply the **Load** without being in parallel with the **Mains**.

**MPM** – Type of plant working in **Island mode** and gensets working in parallel among them.

**SSB + SSTP** (Single Stand By + Single Short Time Parallel) - Type of plant where the genset starts and supplies the **Load** in case of **Mains failure**; once back to normal conditions, it carries out a short time parallel with the **Mains**, it disconnects from the **Mains** and from Load and it stops in stand-by. Depending on the configuration of the plant, it is also possible to synchronize the **Genset** with the **Mains** before disconnecting it in order not to leave the Load without supply.

## 5 Main functions

### 5.1 Front Panel GC315<sup>Mains</sup>, GC315<sup>Plus</sup> and GC315<sup>Link</sup>

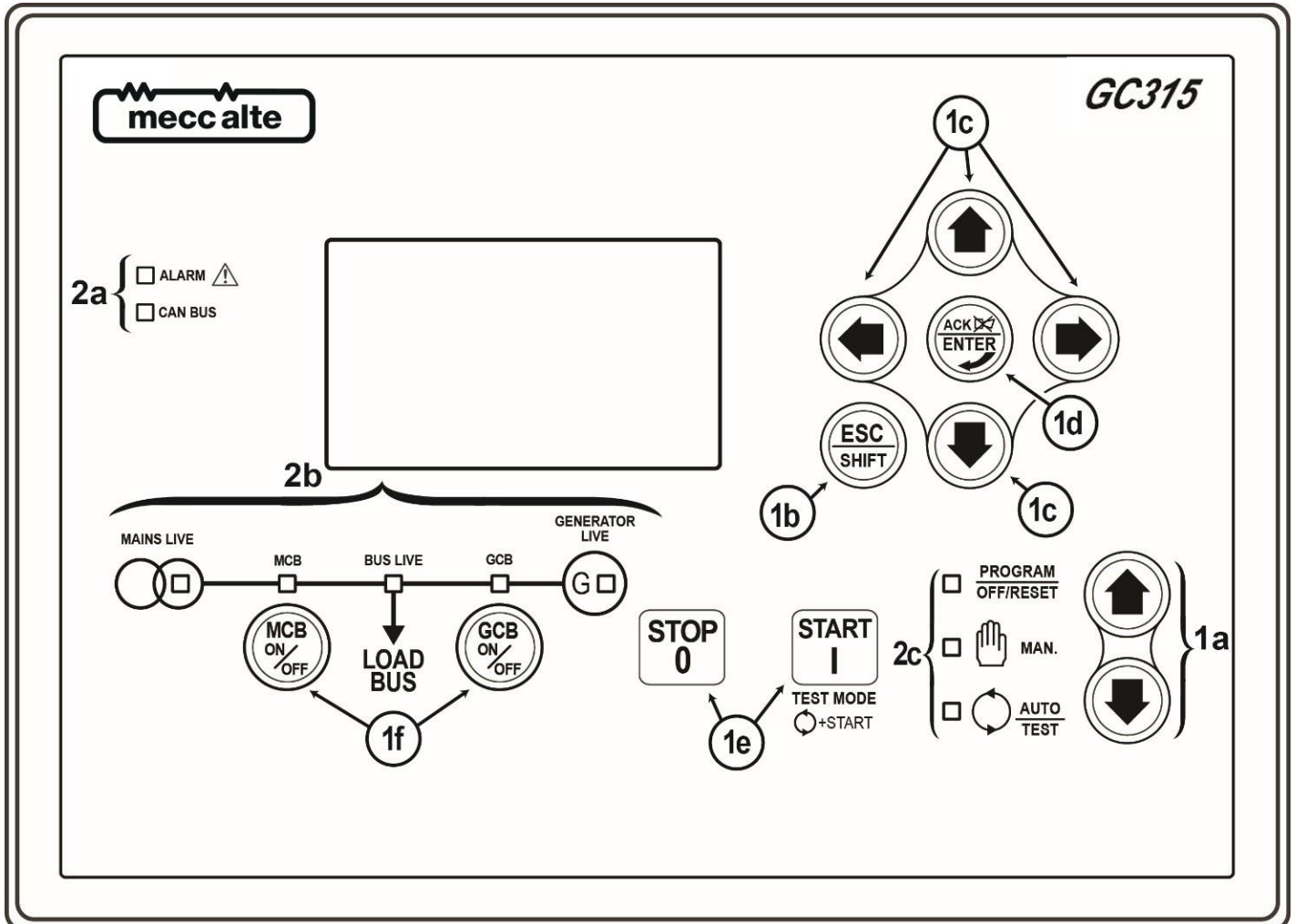

Fig. 1 – Front Panel GC315

#### KEY GC315<sup>Mains</sup> /GC315<sup>Plus</sup>/GC315<sup>Link</sup>

1 - Buttons

2 - Indicators

The controls consist of 12 buttons (1a, 1b, 1c, 1d, 1e, 1f).

The front panel also has some luminous indicators (2a, 2b, 2c).

## 5.2 Front Panel GC400<sup>Mains</sup>, GC400<sup>Mains+Link</sup>

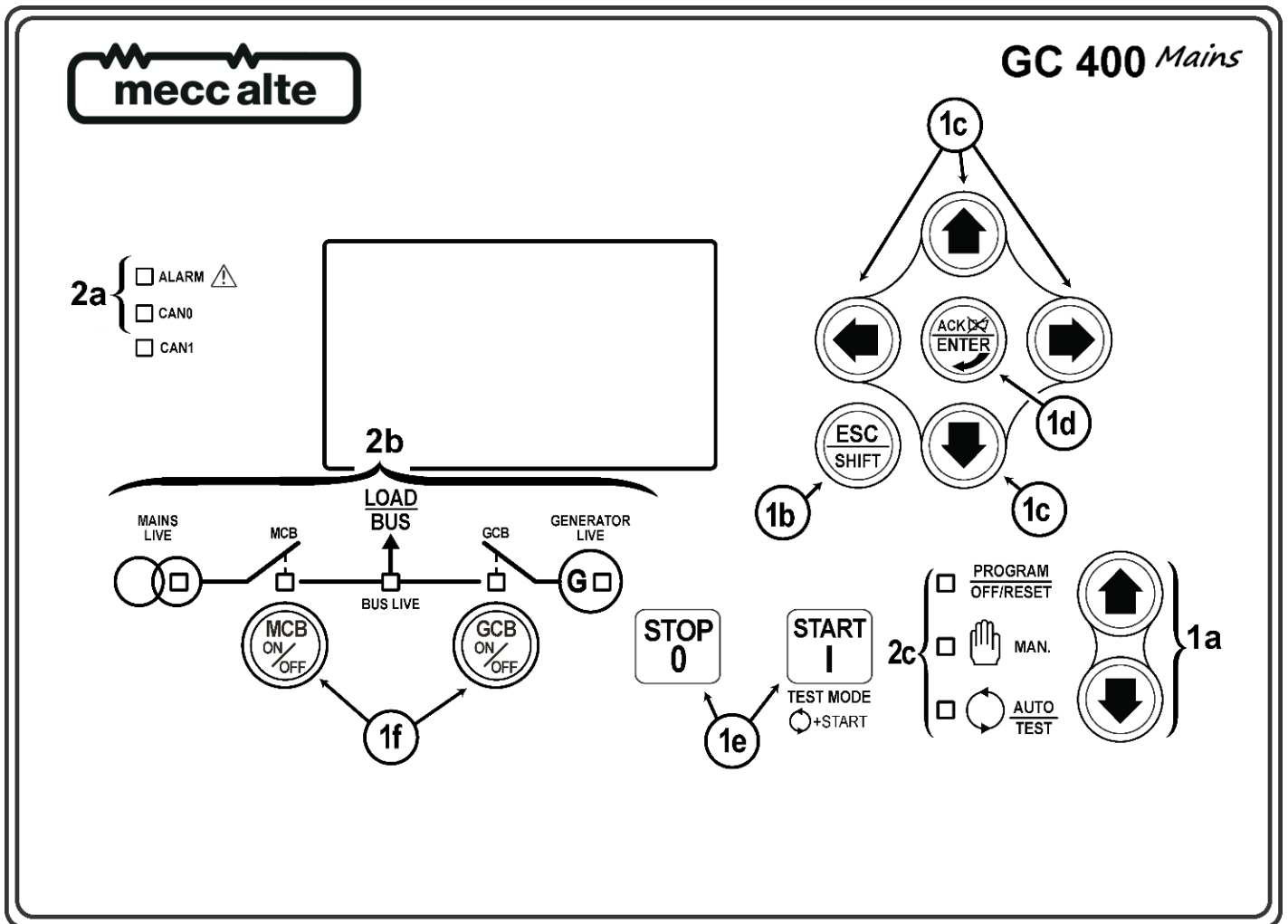

Fig.3 - Front Panel GC400<sup>Mains</sup>, GC400<sup>Mains+Link</sup>













### KEY GC400<sup>Mains</sup>/GC400<sup>Mains+Link</sup>

- 1 - Buttons
- 2 - Indicators













The controls consist of 12 buttons (1a, 1b, 1c, 1d, 1e, 1f).

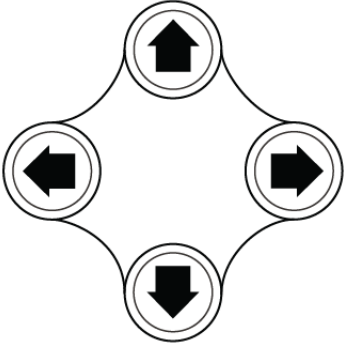



The front panel also has some luminous indicators (2a, 2b, 2c).





### 5.3 Buttons (ref. to fig. 1, 2, 3)

Pushbutton	Function
<p><b>MODE UP</b></p>  <p><b>MODE DOWN</b></p>  <p><b>Ref. 1a</b></p>	<p><b>OFF/RESET PROGRAM</b></p> <p>The genset is disabled; all anomaly signals are disabled. All possible alarms are reset. You can program the parameters.</p>
	<p><b>MAN (Manual)</b></p> <p>The Gen-set control module is set for manual gen-set control.</p> <p>Press the <b>START</b>  button to start the engine.</p> <p>Press the <b>STOP</b>  button to stop the engine.</p> <p>With the engine running and up to speed:</p> <hr/> <p><b>GC315x</b> : Press the <b>MCB</b>  button for manual opening/closing control of <b>Load</b> contactors on the <b>Mains</b>.</p> <p>Press the <b>GCB</b>  button for manual opening/closing control of <b>Load</b> contactors on the <b>Generator</b>.</p> <hr/> <p><b>GC400/GC400<sup>Link</sup></b> : Press and hold down the <b>ESC/SHIFT</b> button , and</p> <p>press the <b>GCB</b> button  for the manual open/close command of <b>MCB</b> circuit breaker with possible synchronisation if configured in the plant.</p> <p>Press the <b>GCB</b> button  for the manual open/close command of <b>GCB</b> circuit breaker with possible synchronisation if configured in the plant.</p>
	<p><b>GC400<sup>Mains</sup>/GC400<sup>Mains+Link</sup></b></p> <p>Press the <b>MCB</b> button  for the manual open/close command of <b>MCB</b> circuit breaker with possible synchronisation if configured in the plant.</p> <p>Press the <b>GCB</b> button  for the manual open/close command of <b>GCB</b> circuit breaker with possible synchronisation if configured in the plant.</p> <p><b>i</b> <b>INFORMATION!</b> <i>For some types of plants, the sequences depend on the Software and Hardware configuration of the plant during the installation activity.</i>  <i>With the BUS under power-on condition, synchronization is required.</i></p>
<p><b>AUTO (Automatic)</b></p> <p><b>TEST</b></p>	<p>The controller automatically manages the genset operation, so it will be started if required by the operating conditions.</p> <p>By pressing the <b>START</b>  button it is possible to activate/deactivate the <b>TEST</b> mode. If there are no other specific configurations, it does not switch the load from <b>Mains</b> to <b>Genset</b> and vice versa.</p>









Pushbutton	Function
	<p> <b>WARNING!</b> The  button, causes the stop of the Generator if running and the activation of a lockout unless configured otherwise.</p>
<p>                      Esc/SHIFT</p> <p></p>	<p>In programming mode, it cancels the changes made to a variable value, brings up the previous menu level, or exits programming mode. If it is kept pressed for at least two seconds in any menu, allows you to exit the programming mode, while retaining the current menu position for further programming access.</p> <p>Depending on the selected page, if pressed together with the  button for at least 5 seconds while in <b>OFF/RESET</b> mode, it can reset counters to zero, reload default values of the programming parameters or cancel history logs (in addition, the <b>CANBUS</b> equipped model allows to force exit from <b>BUS OFF</b> mode). When used during the keyboard regulation function, it aborts the function.</p> <p>If it is pressed in any window, it displays the status information on the upper line (displaying them cyclically).</p> <p>When <b>HELP</b> is available on the page, holding this button down displays the <b>HELP</b> message on the bottom status bar.</p>
<p>                      LEFT/RIGHT</p> <p></p>	<p>Navigation buttons of the multifunction display. These buttons let you select the previous or next page on the display in all modes, except in the <b>PROGRAM</b> mode.</p> <p>In <b>PROGRAM</b> mode, they are used to position the cursor when entering the strings. The horizontal navigation buttons, used in combination with the  button, allow to adjust the contrast.</p> <p>To decrease the contrast (lighten), press the combination of buttons .</p> <p>To increase the contrast (darken), press the combination of buttons .</p> <p>In <b>PROGRAM</b> and <b>HISTORY LOGS</b> mode you can scroll the menus and the variables/settings. You can increase/decrease the value of the variable to change the settings. Used in combination with the  button you can scroll through the menu ten entries at a time or increase/decrease the variables ten units at a time.</p>
<p>                      ENTER/ACK</p> <p></p>	<p>In the <b>PROGRAM</b> menu, you can enter the programming mode and open a submenu, change a variable or parameter, and confirm the operation. In the <b>LOG</b> menu, you can activate the <b>HISTORY LOG</b> function and open the selected log, “acknowledge” any EEPROM errors at power-up.</p> <p>Upon the occurrence of an alarm or lockout, the pressing of the button recognizes the presence of an error and turns off the siren. A further press of the button resets any alarm signals if the operating conditions have returned</p>





Pushbutton	Function
	<p>to normal. Lockout signals can only be reset by activating the "OFF/RESET" mode.</p>
 <p><b>MCB</b></p> <p>Ref. 1f</p>	<p><b>GC315/GC315<sup>Plus</sup> /GC400<sup>Mains</sup>/GC400<sup>Mains+Link</sup></b> : The button is disabled in the "OFF/RESET", "AUTO" and "TEST" modes.</p> <p>In "MAN" it is used to open and/or close the <b>Mains</b> contactor to the <b>Load</b> line.</p> <p>To open the <b>Mains</b> switch <b>MCB</b>, with the engine idle, press and hold the "MCB" button <u>for at least 5 seconds</u>.</p> <p>This button is not present on the devices <b>GC400/GC400<sup>Link</sup></b> . Use the buttons combination <b>Esc/SHIFT</b>  and the button <b>GCB</b>  for the manual open/close command of the <b>MCB</b> circuit breaker with possible synchronisation.</p> <p><b>i</b> <b>INFORMATION!</b> <u>For some types of plants, the sequences depend on the Software and Hardware configuration of the plant during the installation activity.</u>  <u>With the BUS under power-on condition, synchronization is required.</u></p>
 <p><b>GCB</b></p> <p>Ref. 1f</p>	<p>It is used to command the General Circuit Breaker (GCB) or the changeover switch.</p> <p>The button is disabled in the "OFF/RESET", "AUTO" and "TEST" modes. In "MAN" it is used to open and/or close the <b>Generator</b> contactor to the <b>Load</b> line. The closure of the <b>Load</b> line to the <b>Generator</b> is only possible if the relative electrical measures are within tolerance range.</p> <p><b>GC315x</b>: immediate closing of the genset circuit breaker.</p> <p><b>GC400</b>: the button function depends on the plant configuration. In parallel mode with at least one other source powering the BUS, if the button is pressed it activates the fast unload ramp before the circuit breaker opens. In case no ramp is needed, simply keep it pressed for a few seconds until the GCB is opened.</p> <p><b>i</b> <b>INFORMATION!</b> <u>For some types of plants, the sequences depend on the Software and Hardware configuration of the plant during the installation activity.</u></p>
 <p><b>START</b></p> <p>Ref. 1e</p>	<p>In <b>MAN</b> mode it can be used to start the engine.</p> <p>The button can be configured in two ways:          Fully manual (the starter motor is engaged all the time the button is pressed or until the engine running is detected).          Fully automatic (simply press and release the "START" button to activate an</p>

Pushbutton	Function
	<p>automatic start sequence. If the start is not successful, start failure anomalies will not be reported. The “<b>START</b>” button must be pressed and released again to perform a new start attempt.</p> <p>In <b>AUTO</b> mode, it enables/disables the <b>TEST</b> status. When the Gen-set control module is activated, keeping it pressed at the same time as the  <b>STOP</b> button allows access to the special functions.</p>
 <b>STOP</b> 	<p>Used to control the stop of the engine in “<b>MAN</b>” mode.</p> <p>The button can be configured in two ways:</p> <ol style="list-style-type: none"> <li>1) Stop of the engine in <b>AUTO</b>, <b>TEST</b> or <b>REMOTE START</b> mode with the activation of a lockout.</li> <li>2) No function. The enabling of the button in <b>AUTO</b>, <b>TEST</b> or <b>REMOTE START</b> is irrelevant.</li> </ol> <p>Pressed with the Gen-set control module in <b>OFF/RESET</b> mode, runs the <b>LAMP TEST</b> on all the indicator lights. When the Gen-set control module is activated, keeping it pressed at the same time as the <b>START</b>  button allows access to the special functions.</p>

## 5.4 Indicators (ref. to fig. 1)

LED OFF	LED steady ON	LED flashing
<input type="checkbox"/>	<input checked="" type="checkbox"/>	<input checked="" type="checkbox"/>

	Signalling		Function
 <b>PROGRAM OFF/RESET</b> 	<b>PROGRAM OFF/RESET</b>	<input checked="" type="checkbox"/>	Operation mode set to OFF/RESET
		<input checked="" type="checkbox"/>	Indicates that you are accessing the PROGRAMMING menu
		<input type="checkbox"/>	Different operation mode.
 <b>MAN.</b> 	<b>MANUAL</b>	<input checked="" type="checkbox"/>	Operation mode set to MANUAL
		<input type="checkbox"/>	Different operation mode.
 <b>AUTO TEST</b> 	<b>AUTO TEST</b>	<input checked="" type="checkbox"/>	Operation mode set to AUTO
		<input checked="" type="checkbox"/>	Flashing 50% - Operation mode set to TEST
		<input checked="" type="checkbox"/>	Flashing 90% ON - Operation mode set to REMOTE START-UP
	<b>ALARM</b>	<input checked="" type="checkbox"/>	Indicates the presence of at least one lockout or power-off.

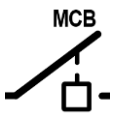
	Signalling		Function
<input type="checkbox"/> <b>ALARM</b>   Ref. 2a		<input checked="" type="checkbox"/>	Signals at least one warning which has not yet been acknowledged with the “ <b>ACK/ENTER</b> ” button.
		<input type="checkbox"/>	No lockouts or warnings.
<input type="checkbox"/> <b>CAN BUS</b>  Ref. 2a	<b>INTERFACE            ECU STATUS</b>	<input checked="" type="checkbox"/>	Signals that the <b>CAN-BUS</b> interface is active and in <b>ERROR-ACTIVE</b> mode. (J1939 or MTU)
		<input checked="" type="checkbox"/>	Flashing at 25% ON signals a COM error (J1939 or MTU): the port is in <b>ERROR-PASSIVE</b> mode. Flashing at 75% ON signals a COM error (J1939 or MTU): the port is in <b>BUS-OFF</b> mode.
		<input type="checkbox"/>	Indicates that the <b>CAN-BUS</b> has been disabled.
<b>MAINS LIVE</b>    Ref. 2b  <b>DISABLED            MAINS LIVE</b>  <input type="checkbox"/>	<b>MAINS LIVE</b>	<input checked="" type="checkbox"/>	<b>Mains</b> power is ON and stable in the tolerance range. The <b>MAINS SIMULATION</b> digital input is enabled from the set time.
		<input type="checkbox"/>	The <b>Mains</b> power is OFF. The <b>MAINS SIMULATION</b> digital input is disabled.
		<input checked="" type="checkbox"/>	Flashing at 50% during transition between the previous two status. Flashing at 25% the <b>Mains</b> power is on but below the tolerance range.
		<input checked="" type="checkbox"/>	Flashing at 75% the <b>Mains</b> power is on but over the tolerance range.
<b>GENERATOR LIVE</b>    Ref. 2b	<b>GENERATOR LIVE</b>	<input checked="" type="checkbox"/>	<b>Generator</b> voltage and frequency are present and steady within the tolerance range.
		<input type="checkbox"/>	<b>Generator</b> voltage and frequency are not present.
		<input checked="" type="checkbox"/>	Flashing at 50% during transition between the previous two status. Flashing at 25% ON - Power and frequency under tolerance range.
		<input checked="" type="checkbox"/>	Flashing at 75% ON - Power and frequency above tolerance range.
<b>MCB</b>    Ref. 2b  <b>MCB</b>  	<b>MCB</b>	<input type="checkbox"/>	The MCB switch is opened.
		<input checked="" type="checkbox"/>	The MCB switch is closed.
		<input checked="" type="checkbox"/>	Flashing at 25% ON if the KG is open after a closing command.
		<input checked="" type="checkbox"/>	Flashing at 75% ON - If closed after an Open command.

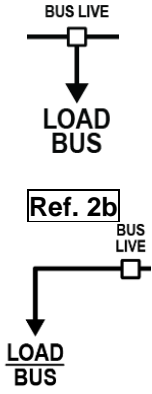
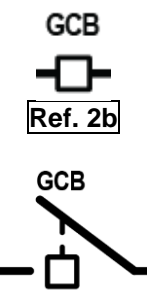
	Signalling		Function
	BUSLIVE	<input checked="" type="checkbox"/>	Signals <b>BUS</b> line ON.
		<input type="checkbox"/>	Signals <b>BUS</b> line OFF.
		<input checked="" type="checkbox"/>	Flashing at 50% if the <b>BUS</b> line voltage is outside tolerance range.  <b>GC400x</b> Flashing at 50% - During synchronization phase (opposite sequence to GCB).
	GCB	<input type="checkbox"/>	The GCB switch is opened.
		<input checked="" type="checkbox"/>	The GCB switch is closed.
		<input checked="" type="checkbox"/>	Flashing at 25% ON if the KG is open after a closing command.  Flashing at 75% ON - If closed after an Open command.

## 5.5 Multifunctional display





### 5.5.1 LCD lighting

The back light lamp is managed by the Gen-set control module, which switches off the back light after a programmable time (**P.492**) if no buttons are pressed in the meantime. Press any

button to switch the lamp ON again, (we recommend using the Esc/SHIFT  button as it has no function when used alone). This function can be disabled by setting parameter **P.492** to 0.

### 5.5.2 Contrast adjustment



Depending on the environmental temperature conditions, the contrast may require adjustment in order to view the display correctly.

Press in sequence the Esc/SHIFT  button + LEFT  to reduce the contrast (lighten),  
 press the Esc/SHIFT  button + RIGHT  to increase it (darken).

### 5.5.3 Mode navigation (ref. to fig. 2)

The display has different display modes with various pages.

Mode	Description	Page identifier
PROGRAMMING	Programming	P.XX
STATUS	Status information	S.XX
MEASURES	Electrical measurements	M.XX
ENGINE	Engine measurements	E.XX
<b>GC400</b> PMCB	Parallel functions	B.XX
HISTORY	History logs	H.XX

Generally, navigation between modes takes place via buttons **UP**  and **DOWN**  **Ref. 1c**.

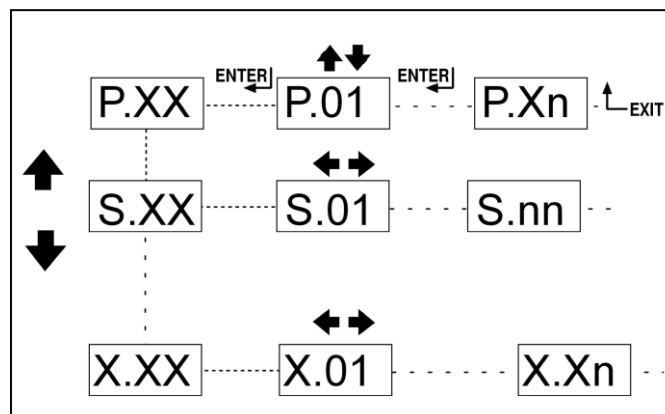











Fig. 2 - Mode navigation

Use the **LEFT**  and **RIGHT**  **Ref. 1c** buttons to display the pages in the mode.

In some modes (e.g.: mode P.xx and mode H.xx) to view the pages, the **ENTER**  button, and then the **UP**  **Ref. 1c** and **DOWN**  **Ref. 1c** buttons must be pressed to navigate between pages.

If the **UP**  and **DOWN**  buttons have to be used to manage the functions within the mode, the **ENTER**  button must be pressed to activate the said functions, and the **Esc/SHIFT**  button to deactivate them.

#### 5.5.4 Display area layout (ref. to fig. 3)

KEY:  
1 - Status bar  
2 - Data area

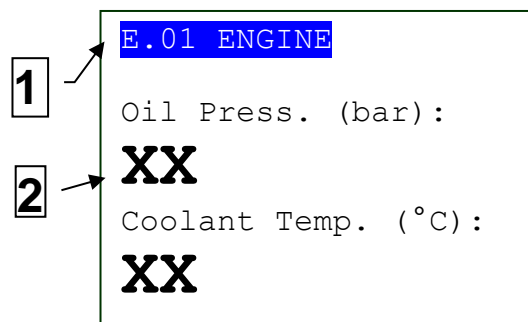

Fig. 3 - Display areas

#### 5.5.5 Top status bar (ref. to fig. 4)

The top status bar contains information on navigation, times and/or some status information.

KEY:  
1a - Mode identifier  
1b - Page identifier  
1c - Page title  
2 - System status

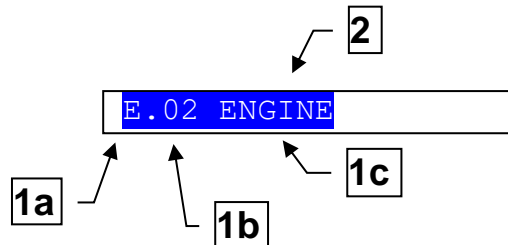



Fig. 4 - Top status bar

The current mode is shown in the relevant field of the top status bar (1a).

The mode identifier (1a), and the page identifier (1b) identify and refer to the page so there is no chance of error.

The system status (2) displays part of the information of page **S.01**(STATUS) that is useful to the operator, as it can be displayed even if other pages or display mode are being accessed.

In some pages, pressing the **Esc/SHIFT**  button replaces the upper status bar with **System** 

**Status** message all the time the button is held down. By double clicking the **Esc/SHIFT**  button, the upper status bar is replaced with a **System Status** message so long as you remain on that page. If the message is unavailable, the bar is cleared and restored when the button is released.

## 5.6 Display mode

### 5.6.1 Programming (P.xx)

 **WARNING!** *Assigning an incorrect value to one or more parameters can cause malfunctions, damage to things or injury to people. The parameters must only be changed by qualified personnel. Parameters can be protected by password (see par. Access codes).*

This mode allows the display and change of the programming parameters.

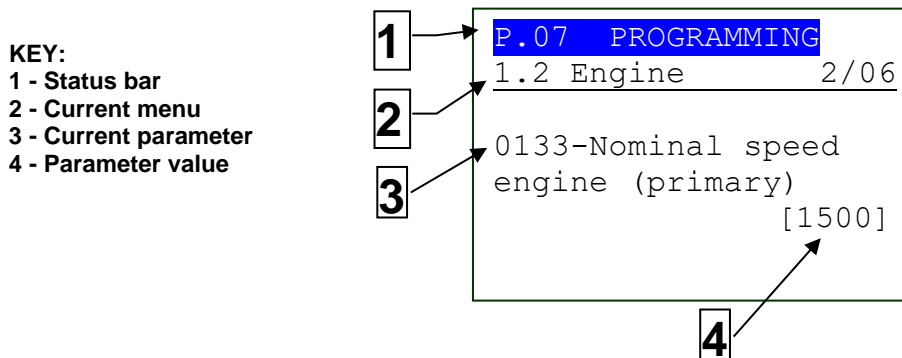

Fig. 3 - Display areas

Each programming parameter **Ref. 3** has a 4-digit numeric code (e.g. **P.0133**) to identify the variables regardless of the language used. The current value of the parameter is displayed below the description **Ref.4**.

The first line **Ref.2**, below the upper status bar, allows to identify the current menu using the ID number of the menu and the associated text. A pair of numbers is displayed on the right of this line, 2/06 in the example in **fig. 3**.

The first indicates which entry in the menu is selected or which page is displayed, the seconds indicates how many entries or pages can be displayed in the current menu/submenu.

#### 5.6.1.1 Access codes

Access to the parameters programming mode can be controlled by 3 different **PASSWORD** levels, which are listed in order of priority.

1. **Mecc Alte password GC400x**
2. **Manufacturer password**
3. **Installer password**
4. **User password**



***If the password is lost, you can reconfigure it using a higher level password. Contact our service centre if the "MANUFACTURER" password is lost.***

Enter the authentication password on page **1.1.1.Authentication**. To access, enter the various menus and submenus following the path: **PROGRAMMING, 1. SYSTEM, 1.1 Safety, 1.1.1. Authentication**

The **(000-Access Code)** page of the **Safety 1/02** menu requires the setting of the access code if one or more passwords have been assigned.

The Password/s can be modified or cancelled (authentication level or lower) in submenu **1.1.2 Password**, after being authenticated with the password.

If a password is set to 0, it is not assigned and not required.

The **USER** can only display and change the User Password.

The **INSTALLER** can change the User Password and the Installer Password.

The **MANUFACTURER** can display and change all three passwords.

Mecc Alte can display and change some critical parameters for configuring the plant parallel function.







 **Warning: The critical parameters must not be changed by the user.**

In programming mode, if the page for changing the password isn't displayed when the Password is entered, press **Esc/SHIFT**  to return to the previous menu and try opening the page again.





The set access code remains in the memory for about 10 minutes after programming has been completed. After that it must be entered again to access the programming mode.

### 5.6.1.2 Setting the parameters

In the **PROGRAMMING** page, enable the mode with the **ACK/ENTER**  button.

Use the **UP**  **Ref. 1a** and **DOWN**  **Ref. 1a** navigation buttons to select a menu and **ACK/ENTER**  to open it. Select the variable or submenu with the **UP**  **Ref. 1a** and **DOWN**  **Ref. 1a** navigation buttons. Pressing **ACK/ENTER**  when there are no submenus, displays the page of variables for the menu entry.

The value of the variable is displayed in square brackets, for example: [0400]

To change the variable, press **ACK/ENTER** ; the square brackets [...] will flash. Use the **UP**  and **DOWN**  navigation buttons to modify the value and press **ACK/ENTER**  to confirm or **Esc/SHIFT**  to cancel the modification.

The variation of the parameters requires the “**OFF/RESET**” operating mode.

Some parameters can also be modified with operating modes different than “**OFF/RESET**”.





If it is not permitted to change a value in any condition, it will be represented in the following manner: <400> showing that the parameter cannot be changed in this status.

To exit the programming menu, use the **Esc/SHIFT**  button.

### 5.6.1.3 How to input string value

Some parameters require the setting or modification of the alphanumeric strings.

In this case, pressing **ACK/ENTER**  makes the square brackets [...] around the variable flash, and a cursor appears under the first character of the string.

Using the **LEFT**  and **RIGHT**  buttons, you can select which character to change. Then, use the **UP**  **Ref. 1a** and **DOWN**  **Ref. 1a** buttons to change the character selected. Repeat the procedure for each character that needs changing.

Use **ACK/ENTER**  (confirm) or **Esc/SHIFT**  (abort) to end the procedure.

### 5.6.1.4 Direct access to the previous page

You can open the last programming page displayed directly. This is possible if, when exiting programming mode, instead of going back through the menus until you exit programming, you hold down

**Esc/SHIFT**  for approximately 2 seconds.

It is also possible to obtain the same result entering programming mode after Gen-set automatically exited programming. This occurs if, for 60 consecutive seconds, no operations are performed on the programming or if the operating mode is changed to “**MAN**” or “**AUTO**”.



### 5.6.1.5 Alarms and protection parameters

Protections and alarms can generally be configured using dedicated variables. Generally, the trip time can also be configured.

 **INFORMATION!** Setting the trip time of the parameters to 0 disables the protection.

## 5.6.2 Status information(S.xx)

In this mode, the information on the system status are supplied.

You can scroll through the various pages using the **LEFT**  and **RIGHT**  buttons.

Page **S.01 (STATUS)** shows system status information. Part of this information are displayed

in the upper title bar if you press and hold the **ESC/SHIFT**  button.

The page **S.02 (ANOMALIES)** is automatically displayed in case a new anomaly arises. For every anomaly, it is shown:

- A letter that identify the type:
  - "A": Alarm (block).
  - "U": Unload (only **GC400x**).
  - "D": Deactivation.
  - "W": Warning.
- A three digit numeric code that uniquely identify the anomaly. This code flashes if the

anomaly has not been acknowledged yet with **ACK/ENTER** .

The page **S.03(GC315Plus/GC315Link)/S.04 (GC400x) (SERIAL COMMUNICATION)** displays the status of the serial communication towards the two serial ports and by USB. In the case of operating errors, check the information in this page.

For each serial port (and for the USB too) the status is displayed (stand-by, communicating, etc.).

On the *Link* controllers or in case the controller is connected to an external modem on the RS232 serial port, the two first lines display:

- The modem model
- The name of the telephone provider.
- The GSM signal level

The page **S.04(GC315Plus/GC315Link) /S.05 (GC400x) (NETWORK)** displays the status of the connection and of the TCP/IP communication on the Ethernet interface or via GPRS.

On the controllers GC315<sup>Plus</sup> and GC400 (equipped with ETHERNET interface), the controller shows the connection status:

The page **S.05(GC315<sup>Plus</sup>/ GC315<sup>Link</sup>)/S.07(GC400x)/ (CAN\_BUS)** displays the status of the CAN-BUS interfaces of the controller. Each interface displays

- The communication status of the bus. There are three possible signalling:

- - ERROR-ACTIVE: normal operation
- - ERROR-PASSIVE: communication is working despite faults (errors).
- - BUS-OFF: Gen-set has interrupted the connection to the bus due to too many errors.
- Communication error counters are displayed. The counters of the instantaneous transmission/reception errors and the maximum values reached are displayed. It is possible to reset the maximum values (and force the output status of BUS-OFF) by

pressing for 5 seconds the buttons **ACK/ENTER**  (confirm) and **Esc/SHIFT** .

The **S.06(GC315x)/S.03(GC400x) (CONTROLLER)** page displays the specific information of the Gen-set: language set, date/time, serial number (ID code), firmware revision.

- **Only for GC400x:** the necessary internal code to have a temporary Mecc Alte level password.

The pages **S.07-08-09(GC315x)/S.08-09-10(GC400x) (GENERIC STATUS)** display the general status of the digital inputs. Information!: Digital inputs assigned as Warnings, Lockouts or Power-offs do not come under this category. The generic status functions, and the display priority of the same in the pages are pre-assigned when configuring the system parameters.

The page **S.10(GC315x)/E.11(GC400x) (FUEL PUMP)** (available only if the fuel pump management output is configured) contains information and commands related to the fuel pumps.

The page **S.11 (GC315x) (DIGITAL INPUTS)** displays the status of:

- Digital inputs
- Analogue inputs used as digital (if they are not used as digital they are displayed with hyphens).
- Virtual digital inputs

The page **S.12 (GC400x) (DIGITAL INPUTS)** (not available on GC315) is displayed only if DITEL modules have been configured.

The page **S.13 (GC315x) (DIGITAL OUTPUTS)** shows the status of the controllers digital outputs.

Pressing the **ACK/ENTER**  button, scrolls through three different pages (**LOGIC STATE, PHYSICAL STATE, BY FUNCTION**), showing the status of the digital inputs:

- **LOGIC STATE:** The output's logic state (active or inactive) controlled by the Gen-set in the management of the operating sequence.
- **PHYSICAL STATE:** Electrical level (active or inactive, or high or low) actually present on the output; this can be the opposite in comparison to the corresponding logic state. Displayed in negative.
- **BY FUNCTION:** Displays the main states of the digital outputs.

The page **S.14 (GC315<sup>Plus</sup>/ GC315<sup>Link</sup>/GC400x) (DIGITAL OUTPUTS)** is displayed only if DITEL modules have been configured. It displays the status of the DITEL digital outputs. The page is available only if the **DITEL** expansion module is installed in the system.

The page **S.15 (GC315x/GC400x) (ANALOGUE INPUTS)** displays the value of the controller analogue inputs.

The page **S.16 (GC315<sup>Plus</sup>/ GC315<sup>Link</sup>/GC400x) (ANALOGUE INPUTS)** displays the value of the controller analogue inputs. The page is available only if one or more **DITEMP** or **DIGRIN** modules are installed in the system.

The page **S.17 (GC315<sup>Plus</sup>/ GC315<sup>Link</sup>/GC400x) (ANALOGUE INPUTS)** displays the value of the controller analogue inputs. The page is available only if the **DIVIT** expansion module is installed in the system.

The page **S.18 (GC400x) (ANALOGUE OUTPUTS)** displays the value of the controller analogue outputs and the related function.

The page **S.18 (GC315<sup>Plus</sup>/ GC315<sup>Link</sup>) (ANALOGUE OUPUTS)** displays the analogue outputs value of the **DANOUT** expansion module. The page is available only if the **DANOUT** expansion module is installed in the system.

The page **S.20 (GC400x) (MAINS PROTECTION)** is displayed only if the type of plant considers the temporary parallel with the mains.



It displays the status of all protections of parallel with the mains. The disabled protections are not displayed. For each protection enabled, the controller displays a text (for example "27<<": it is displayed in reverse if the protection is enabled - mains out of tolerance). Possible codes are: "27<<", "27<", "27T", "27Q", "59>", "59>>", "81<<", "81<", "81>", "81>>", "81R", "VJ", "MC" (by MC100), "DI" (by contact).

The page **S.20(GC315<sup>Plus</sup>/ GC315<sup>Link</sup>) /S.06 (GC400x) (SMARTCLOUD)** displays the controller name (useful to find it in the "SMARTCLOUD" system) and the IP address of the "SMARTCLOUD" server (in case of internal GPRS modem, the IP address is replaced by the DNS name of the server). Moreover, it displays the communication status with the server:

- "Stand-by".
- "Operating".
- "Error".
- "No answer".

### 5.6.3 Electrical measurements(M.xx)

You can scroll through the various pages using

the LEFT  and RIGHT  buttons.

This lets you display the measurements taken by Gen-set on the electric lines.

Page **M.01 (SYSTEM)** displays a wiring diagram of the system. The states of the switches, the **MAINS**, the **GENERATOR** and the electrical values depend on the system configuration. This windows allows you to change the power supplied in the mains parallel applications in **BASE LOAD** and **IMPORT/EXPORT** operation (par. 6.2.2).

- Page **M.02 (MAINS/BUS 1)** displays the main electrical values of the **Mains/Bus** (Phase to Phase voltages, Frequency and Rotation direction).
- Page **M.03 (MAINS/BUS 2)** displays the main electrical values of the **Mains/Bus** (Phase to Neutral voltages, Neutral voltage and Rotation direction).
- Page **M.04 (GENERATOR 1)** displays the main electrical values of the **Generator** (Phase to Phase voltages, Frequency and Rotation direction).
- Page **M.05 (GENERATOR 2)** displays the main electrical values of the **Generator** (Phase to Neutral voltages, Neutral voltage and Rotation direction).
- Page **M.06 (CURRENTS)** displays the phase currents of the **Generator/Load**, the negative sequence current, the auxiliary current, the neutral current and the differential current.
- Page **M.07 (POWER VALUES 1)** displays the total power, the power factor, the power values and the phase power factor.
- Page **M.08 (POWER VALUES 2)** displays the total reactive and apparent power, the total reactive and apparent phase power values.
- Page **M.09 (ENERGY 1)** displays the **Load/Generator** partial energy counters (active and reactive energy), total energy (active and reactive energy).
- Page **M.10 (ENERGY 2)** displays the **Load/Mains** partial energy counters (active and reactive energy), total energy (active and reactive energy). Available only if the configuration of the CT (Current Transformer) is set to **Load**
- Page **M.11 (AUX MEASURES)** displays the additional information on genset voltages and currents, used for the protection of the 27Q mains parallel.
- Page **M.12 (REGULATIONS) (GC400x)** displays genset and mains/bus voltages and frequencies at the same time. It displays the parameters used to monitor the parallel operation. This windows allows you to change the power supplied in the mains parallel applications in **BASE LOAD** and **IMPORT/EXPORT** operation (par. 6.2.2).
- Page **M.13 (SYNCHRONISATION) (GC400x)** displays the synchronisation information. The use of the displayed synchronoscope in MAN mode allows the manual synchronization (par. 6.2.1).
- Page **M.14 (PARALLEL) (GC400x)** displays the information when the genset is in parallel with the mains or other gensets. It displays the active and reactive power and the power factor. It also displays currents, medium voltage and genset frequency. This windows allows you to change the power supplied in the mains parallel applications in **BASE LOAD** and **IMPORT/EXPORT** operation (par. 6.2.2).



**INFORMATION!** *Some of the data is not displayed in mono-phase configuration.*

## 5.6.4 Engine measurements (E.xx)

This mode shows the measurements of the engine operation parameters.

Page **E.01 (ENGINE 1)** displays the main values of the engine: Oil pressure (bar), Coolant temperature (°C) and engine speed (rpm).

Page **E.02 (ENGINE 2)** displays the starter battery voltage (V) and the fuel level (%).

Page **E.03 (COUNTERS)** displays the starter and hours of work counter (partial and total hours, load hours, Override and hours until the next maintenance).

The number of pages displayed may depend on the type of engine (**J1939**, **MTU** or **without communication interface**).

The page **E.04 (GERAFLEX) (GC400x)** is displayed on if the CANBUS engine selected in parameter P.0700 is "240 GERAFLEX".

The pages **E.04, E.05, E.06, E.07, E.08, E.09, E.10 (CANBUS 1...6) (GC315<sup>Plus</sup>, GC315<sup>Link</sup>, GC400x)** (available only with **GC315<sup>Plus</sup>** and if the CANBUS configuration has been enabled) display the values acquired by CANBUS.

 **INFORMATION!** : *The display of some parameters depends on the engine model used.*

The page **E.11 (GC400x) (FUEL PUMP)** (available only if the fuel pump management output is configured) contains information and commands for the fuel pumps.

The pages **E.10-11-12 (GC315x)/E.12-13-14 (GC400x) (EXTERNAL MEASURES)** display the measures acquired by the analogue inputs configured as generic sensors.

The page **E.13(GC315x)/E.14 (GC400x) (MAINTENANCE)** displays the counters related to the Genset maintenance.

## 5.6.5 PMCBus

In this mode, measures and statuses connected to CANBus PMCBus are displayed.

The page **B.01 (MC100/BTB100)** displays, for diagnostic purposes, the mains controllers (MC100) and tie breaker controllers (BTB100) connected to the PMCBus.

The pages **B.02, B.03, B.04 (GENSETS) (GC400x)** display the information related to the **PMC-Bus** mains (PMC-Bus address, active and reactive power) up to 7 gensets.

The page **B.05 (PMCB)** displays the total nominal power of the gensets (MDPt, kW), the total active power (kW), the total reactive power (kvar), the total active energy (kWh) and the total reactive energy (kvarh).

The pages **B.06, B.07 (LOAD MANAGEMENT) (GC400x)** display the information related to the load function. This includes the number of network devices, the operating mode of the load function, the identifier of the pilot generator and the list of priorities.

### 5.6.6 History logs(H.xx)

This mode allows you to access events and data log display.

A number and time&date stamp identifies each record.

The number shows in the top right line of the multifunctional display with the total number of records.

When the archive is full, a new record overwrites the old one; so the identification number may change in time.



To activate the mode, press the **ACK/ENTER** button. A menu will guide you to the selection of the desired function.

## 6 Operating principles

### 6.1 GC315, GC315<sup>Plus</sup>, GC315<sup>Link</sup>

Below are the components of a standard emergency system consisting of a public power line “**Mains**”, a “**Load**” line (the load that you want to feed), a “**Generator**” line (**Generator** set with alternator and drive diesel engine), a control panel containing: a contactor **MCB** to manage the **Mains**, a contactor **GCB** to manage the **Generator**, a device **GC315** or GC315<sup>Plus</sup> to control the engine and the electric lines concerned, an electronic board to adjust the speed of the engine, a battery trickle charger and a number of components to manage the auxiliaries (relays, fuses, terminals, etc ...).

The switching of the **Load** between the **Mains** and Generator and/or vice-versa, is enabled by contactors, mechanically and electrically interlocked, fed by the same line but controlled through the closing and/or opening by the device.

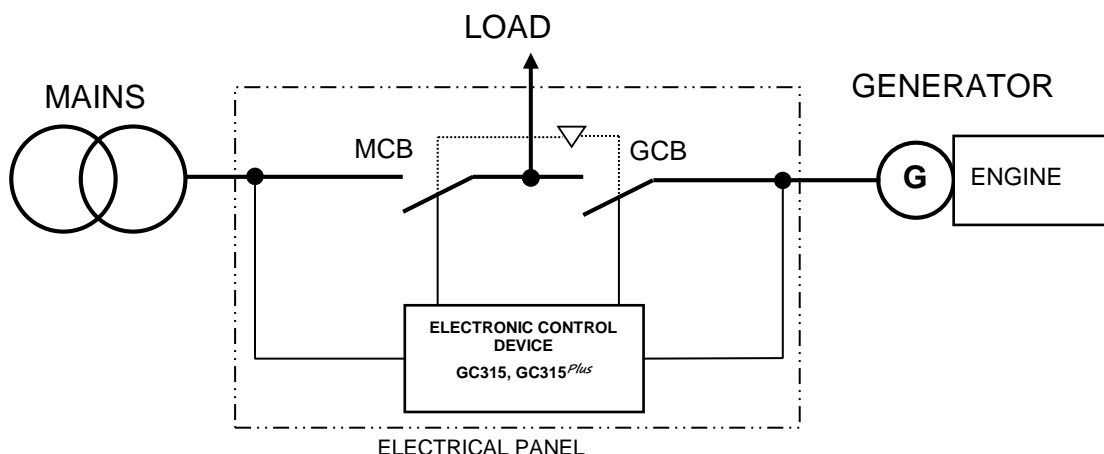



### 6.1.1 Off/Reset

In this mode the **Load** is usually powered by the **Mains** with the **MCB** contactor closed. The supply of the **Load** is guaranteed all the time the **MCB** remains closed because it is fed by the same **Mains**. If a **Black out** occurs on the **Mains**, the **Load** will remain de-energized and the gen-set idle. The protections on the electrical measures and on the engine are disabled.

### 6.1.2 Manual

In this mode the **Load** is usually powered by the **Mains** with the **MCB** contactor closed. The supply of the **Load** is guaranteed all the time the **MCB** remains closed because it is fed by the same **Mains**. The management of the switching between the **Mains** and **Generator** (**MCB** and **GCB** contactors), the starting and stopping of the Generator set are managed entirely by the operator.

The **MCB** contactor is opened after pressing the "**MCB**" button for at least 5 seconds if the **Generator** is not present and immediately if the **Generator** is present in the window (correct voltage and frequency). Closed, regardless if the **Generator** is present or not, immediately when the "**MCB**" button is pressed.

The **GCB** contactor is immediately closed and/or opened, only if the **Generator** is present and stable in the window.

In the event of **Black out** on the **Mains**, the operator must start the Gen-set and manage switching to guarantee the power supply to the **Load**.

Before starting the sequence, check:

- 1) The **Mains** warning light "**MAINS LIVE**" is off or flashing and the **Load** warning light "**BUS LIVE**" is off.
- 2) **MCB** warning light On.
- 3) "**MAN**" mode warning light.

To perform manual switching sequence, proceed as follows:

- 1) Press and hold the "**START**" button until the engine starts. Repeat the starting operation if the engine does not start. The engine and machine alternator protections are active in this mode (oil pressure, coolant temperature, fuel level, over-speed, etc ...).
- 2) Wait for the **Generator** to reach the running voltage/frequency, "**GENERATOR LIVE**" light ON.
- 3) Press the "**GCB**" switching button and check that the "**GCB**" and "**BUS LIVE**" lights are ON.

The **Load** is now powered by the **Generator**. When the **Mains** returns after the **Black out** and/or the restoration of the fault, "**MAINS LIVE**" light ON, switching of the **Load** to **Mains** can be performed. It is the operator decision to keep the power supply from the **Generator**.

 **INFORMATION!** : The switching of the **Load** to the **Mains** causes the **Black out** on the **Load** for the time necessary to correctly switch the contactors.

Switching is enabled by pressing the "**MCB**" button. The **Load** is then powered again by the **Mains**. The gen-set will remain on until the "**STOP**" button is pressed by the operator.

 **INFORMATION!** *Ideally do not stop the Gen-set immediately after switching the **Load** to the **Mains**, but leave it on for the necessary time for the engine to cool. To stop the engine, press the "**STOP**" button.*

### 6.1.3 Automatic

In this mode the main task of the device is to ensure the electrical power to the **Load** in any situation. To implement this task, the device continuously monitors the **Mains** for voltage/frequency faults, phase failure or phase unbalance.

- **Sequence with Mains present:**  
If the **Mains** is within the normal values configured during installation, contactor **MCB** is closed and the **Load** is powered by the **Mains**. The Gen-set is inactive and contactor **GCB** is open.
- Sequence with Mains blackout:  
If the values of the **Mains** are different from that configured during installation (e.g. in the event of a **Black out**), and therefore the **Load** is no longer correctly powered, the device will begin the starting sequence of the generator set. You have:
  - 1) Engine start command: opening command of the **fuel solenoid valve** and/or command on the **actuator** and/or command **CANBUS J1939** to the engine **ECU** (with the maximum number of start attempts and duration of the command set by parameters configured). Activation of the lockout with acoustic warning if the engine has not started after the attempts.
  - 2) Stand-by with voltage/frequency monitoring until the stable operating conditions of the **Generator**. Lockout activation with acoustic warning if after the set time the **Generator** has not reached the normal values for the switching of the **Load**.
  - 3) Switching command between **MCB** and **GCB** with the consequent handling of the **Load** load on the **Generator**.
  - 4) The generating set continues to supply power to the **Load**, monitors continuously the electrical values of the **Mains** and the **Generator**, checks that the engine protections are enabled and ready to intervene; all awaiting the return of the **Mains** voltage at the correct parameters.
- Return of Mains power after Black out

The **Load** line is powered by the **Generator** with **GCB** closed and **MCB** open, but the **Mains** is returning after the **Black out**. If the **Mains** is considered stable and within the tolerance (normal value), the device starts the **Mains** return sequence with the standard procedure.

- 1) Switching command between **GCB** and **MCB** with the consequent handling of the **Load** load on the **Mains**.

 **WARNING! Switching between MCB and GCB or vice versa, creates a blackout on the Load line. The Load will remain de-energized for the set time necessary to ensure a correct switching of the contactors.**

- 2) The generating set keeps running for the cooling phase of the engine (phase for the disposal of excessive heat). Once the engine has cooled, shut-down is enabled through the closure of the **fuel solenoid valve** and/or the command on the **actuator** and/or the **CANBUS J1939** command to the engine **ECU**.
- 3) The **Load** is powered from the **Mains** with **MCB** closed. The **Generator** set is idle with the **GCB** open, ready for any new operation.

 **INFORMATION!** : The operating sequence described above is generic and in some cases may not correspond to the one implemented in your system. For further information, please contact your installer/Manufacturer.

## 6.1.4 Test

The sole purpose of the “**TEST**” sequence is that of testing the **Generator** set in order to check the operating condition in preparation for a possible emergency situation (e.g. a Black out) and to periodically keep the mechanical parts efficient and lubricated.

The **TEST** sequence can be scheduled and executed automatically by the Gen-set control module and periodically with a programming schedule, or manually by means of the operator panel. To activate the manual sequence, the device must be in the “**AUTO**” mode. Pressing the “**START**” button in this mode activates the **Generator** set for the “**TEST**” sequence.

- 1) The “**AUTO/TEST**” light flashes indicating that the “**TEST**” mode has been acquired.
- 2) Engine start command (number of attempts, time of the attempt). Opening command of the **fuel solenoid valve** and/or command on the **actuator** and/or **CANBUS J1939** command to the engine **ECU**.  
Activation of the lockout with acoustic warning if the engine has not started after the attempts.
- 3) The “**GENERATOR LIVE**” light ON indicates the correct voltage/frequency of the **Generator**.
- 4) The engine stays on without switching between contactors **MCB** and **GCB**.
- 5) The operator decides if to stop the “**TEST**” by pressing the “**START**” button again.
- 6)  **WARNING! Pressing the "STOP" button during the test activates an alarm which prevents the restart of the engine, which can only be reset in the "OFF RESET" mode.**
- 7) The “**AUTO**” light remains ON and the engine stops; the stop is controlled by the opening of the fuel solenoid valve and/or the command on the actuator.

 **INFORMATION!** *If a fault occurs on the **Mains** during the “**TEST**” phase, causing the automatic activation of the **Generator**, the operating mode independently passes from “**TEST**” to automatic “**AUTO**”. When the **Mains** returns, the mode remains in “**AUTO**”.*

The “**TEST**” sequence does not foresee the load test with switching from the **Mains** to the **Generator** so as not to cause an unnecessary **Black out** on the **Load**. However, it is possible that your system has been configured to handle the load in “**TEST**” (parameter P.0222).

 **INFORMATION!** *The operating sequence described above is generic and in some cases may not correspond to the one implemented in your system. For further information, please contact your installer/Manufacturer.*

## 6.2 GC400x

The **GC400x** devices can be configured to manage several types of plant and the use modes can vary consequently

For example, please find below some basic operations of a **SSB+SSTP** plant (Single Stand-By + Single Short Time Parallel) and a **MPM** plant (Multiple Parallel to Mains).

### 6.2.1 SSB + SSTP Plants - GC400<sup>Mains</sup> / GC400<sup>Mains+Link</sup>

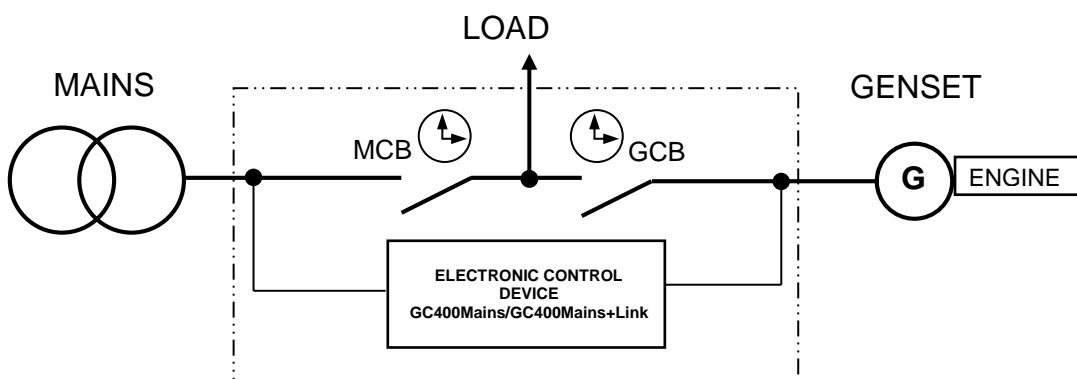

Below a brief example of the operating sequence of a general SSB + SSTP plant; the plant and the sequence are similar to the **GC315x** ones described above in par. 6.1, but when the **Mains** is back the parallel with the **Genset** is carried out in order not to leave the **Load** without supply.

Some sequence steps depend on the configuration of the plant, as the particular circuit breaker management, or the particular Mains/Genset status.

#### 6.2.1.1 Off/Reset Mode

In this mode the Genset is off and the Load is usually supplied by the **Mains** with the **MCB** contactor closed. The supply of the **Load** is guaranteed all the time the **MCB** remains closed because it is fed by the same **Mains**. If a **Black out** occurs on the **Mains**, the **Load** will remain de-energized and the gen-set idle. The protections on the electrical measures and on the engine are disabled.

#### 6.2.1.2 MAN Mode

Usually, this mode is used only for the management of the genset by the skilled operators, mainly to carry out tests on the a plant or in particular situations.

In this mode the **Load** is usually powered by the **Mains** with the **MCB** contactor closed. The supply of the **Load** is guaranteed all the time the **MCB** remains closed because it is fed by the same **Mains**. The management of the switching between the **Mains** and **Generator** (**MCB** and **GCB** contactors), the starting and stopping of the Generator set are managed entirely by the operator.

With Genset off, the **MCB** contactor is commanded to open after pressing the "**MCB**" button for at least 5 seconds. The **Load** stays disconnected.

The engine must be started by the operator by pressing **START**.

With the **Genset** parameters and **Mains** live and with controller configured to manage the synchronisation on the **GCB** contactor pressing the “**GCB**”, the synchronisation is activated. Once the synchronisation is done, the **MCB** contactor is opened and the **Load** stays supplied by the **Genset**.

With **Mains** off and with the **Genset** parameters, by pressing the “**GCB**” button the **GCB** contactor is automatically closed.

With genset running, **Load** supplied by the **Genset** and **Mains** live, by pressing the “**MCB**” button, the synchronisation with the **Mains** is activated. Once the synchronisation is done, the **GCB** contactor is opened and the **Load** stays supplied by the **Mains**. The genset can be stopped by the “**STOP**” button.

During the synchronisation between **Mains** and **Genset**, if necessary, in order to regulate manually the engine speed and/or the voltage, press

 **ENTER** and the buttons **LEFT**  and **RIGHT**  to select speed and voltage

regulation; use the **UP**  and **DOWN**  button to modify the value in percentage (%).

At any time, pressing **EXIT/SHIFT**  disables the speed manual controls and allows page changing.

### 6.2.1.3 AUTO Mode

It is the normal operating mode.

In this mode the main task of the device is to ensure the electrical power to the **Load** in any situation. To implement this task, the device continuously monitors the **Mains** for voltage/frequency faults, phase failure or phase unbalance.

In this mode the **Load** is usually powered by the **Mains** with the **MCB** contactor closed. The supply of the **Load** is guaranteed all the time the **MCB** remains closed because it is fed by the same **Mains**. The management of the switch between the **Mains** and **Generator** (**MCB** and **GCB** contactors), the starting and stopping of the Genset are managed entirely by the operator.

In case of anomaly on the **Mains**, the device automatically:

- Opens the **MCB** contactor
- Starts the genset engine
- With the Genset parameters, carries out the switch of the Load on the Genset by closing the **GCB** contactor
- Once the correct **Mains** conditions are back, automatically starts the synchronisation and closes the **MCB**.
- Once the synchronisation is done, opens the **GCB**. The load are supplied by the Mains again.
- After the time for the engine cooling, the genset is stopped. The device stays in stand-by.

 **INFORMATION!** : The operating sequence described above is generic and in some cases may not correspond to the one implemented in your system. For further information, please contact your installer/Manufacturer.

### 6.2.1.4 Test

The sole purpose of the “**TEST**” sequence is that of testing the **Generator** set in order to check the operating condition in preparation for a possible emergency situation (e.g. a Black out) and to periodically keep the mechanical parts efficient and lubricated.

The **TEST** sequence can be scheduled and executed automatically by the Gen-set control module and periodically with a programming schedule, or manually by means of the operator panel. To activate the manual sequence, the device must be in the “**AUTO**” mode. Pressing the “**START**” button in this mode activates the **Generator** set for the “**TEST**” sequence. The engine stays on, without switch between the **MCB** and **GCB** contactors. It will be up to the operator to end the “**TEST**” by pressing “**START**” again.

**! WARNING!** Pressing the “STOP” button during the test activates an alarm which prevents the restart of the engine, which can only be reset in the “OFF RESET” mode.

**i INFORMATION!** If a fault occurs on the Mains during the “TEST” phase, causing the automatic activation of the Generator, the operating mode independently passes from “TEST” to automatic “AUTO”. When the Mains returns, the mode remains in “AUTO”.

The “**TEST**” sequence does not foresee the load test with switching from the **Mains** to the **Generator** so as not to cause an unnecessary **Black out** on the **Load**. However, it is possible that your system has been configured to handle the load in “**TEST**” (parameter P.0222).

**i INFORMATION!** : The operating sequence described above is generic and in some cases may not correspond to the one implemented in your system. For further information, please contact your installer/Manufacturer.

### 6.2.2 MPM Plants - GC400 and GC400Link

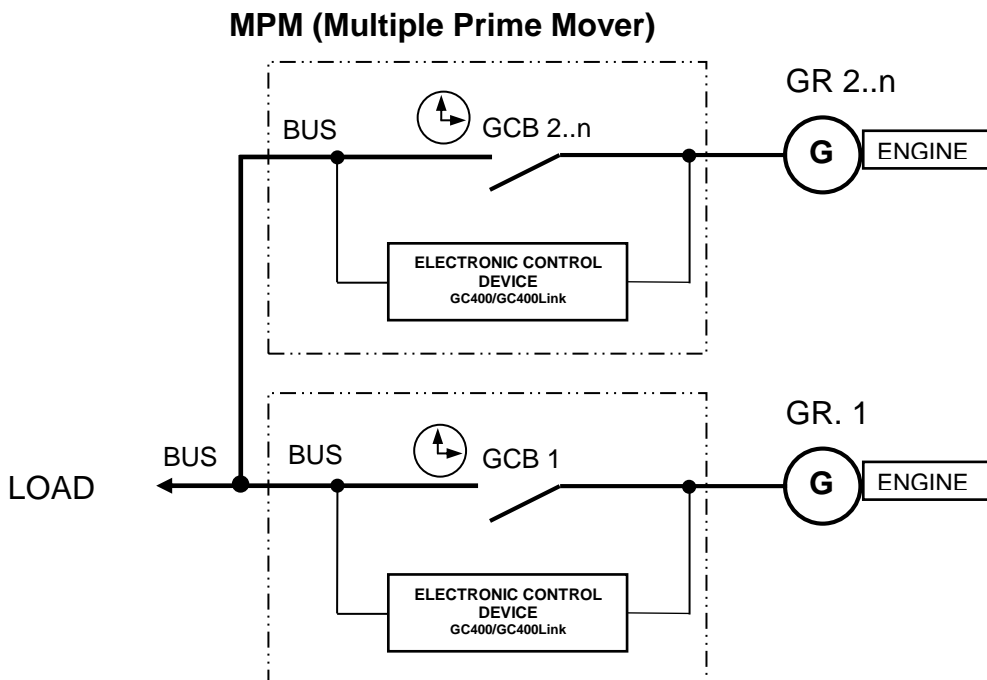

This type of plant considers the presence of more gensets in parallel among them in **island mode** and to supply the **Load**. The normal operation is **AUTO** mode and considers all gensets not in **OFF/RESET** or **MAN** on, in parallel among them and in power sharing.

The power supplied by the single genset is defined by a parameter or an external potentiometer. It can also be regulated manually as indicated below.

The gensets can be switched off automatically, or cyclically, if the load function is activated.

By selecting the **AUTO** mode, with the conditions for the genset operation, the device starts the engine and, after the synchronisation, closes its **GCB** contactor. The power supplied by the genset increases following the load ramp set. Once the power set is reached, the device automatically regulates the active power and potentially the reactive one, sharing it with the other gensets.





If the genset is commanded to stop, the power unload is carried out and the **GCB** is commanded to open. After a cooling cycle, the engine is automatically stopped.

In **MAN** mode, the engine start/stop and **GCB** switch are carried out by the operator. By pressing the "**GCB**" button for the connection of the genset, the synchronisation is activated; **GCB** is closed and the load ramp is activated. When supplying, by pressing the **GCB** button the sequence of power unload is activated and, once over, the **GCB** is opened. Press the "**STOP**" button to stop the engine.

#### 6.2.2.1 Manual power regulation

 **WARNING! As some slow power ramps may have been set, check the command against the "Power reference" value shown in the same page and not against the value of the power actually produced.**

It is possible to regulate manually the power to supply without modifying directly the parameter that defines the regulation power.

Display the page **M.01** (available only for MPM plants), press **ENTER**  to change and the buttons **LEFT**  and **RIGHT**  to select between "power required" and/or "cosfi required"; use the button **UP**  **Ref. 1c** to increase the value and **DOWN**  **Ref. 1c** to decrease the value set in percentage (%). The value to be changed is highlighted as a negative.

 **INFORMATION!** The value modified is acquired and saved without needing to confirm the variation with the **ENTER** button.

Press the **ESC/SHIFT**  button to exit the adjustment procedure.





 **INFORMATION!** Note: The described function is only available if no external potentiometer has been configured for power regulation.

## 7 Special setting

### 7.1 Selecting the language

The Gen-set control module can display the texts in various languages.

To select a language different from that set, view the screen **S.06 (GEN-SET)** using the navigation

buttons. To change the **LANGUAGE** press **ACK/ENTER** : the square brackets [ ] will start flashing. Use the **UP**  and **DOWN**  buttons to display the available LANGUAGES, then press **ACK/ENTER**  to confirm or **Esc/SHIFT**  to cancel the changes.



### 7.2 Date/Time setting

The device includes an internal clock/calendar used primarily for the functions:





- Weekly working hours of the generator set.
- Calendar for the scheduled “TEST”.
- Recording of events with date and time in the history logs.

The calendar/time setting is possible in all operating modes: “OFF/RESET”, “MAN”, “AUTO” or “TEST”.

To update the time and/or date of the device, enter the “4.7.1 Date – Time” menu.

Use the **UP**  and **DOWN**  buttons to navigate between the sub-menus and the **ACK/ENTER**  button to open the sub-menu. The full path to the Date/Time programming page is: “P.03 PROGRAMMING, 4 AUXILIARY FUNCTIONS, 4.7 Device, 4.7.1 Date-Time”.

Press the **ACK/ENTER**  button to view the 6 **Date/Time** pages.

Use the **UP**  and **DOWN** ; navigation buttons to move between the parameters and/or change their values the **ACK/ENTER**  button is used to confirm the value and/or the **Esc/SHIFT**  button to cancel the change.

If the values are between <...> this means you are not authorised to access and modify the parameters. See paragraph 4.5.1.1 **Access codes** to enable authentication for the “User” password.









To return to the start menu, press the **Esc/SHIFT**  button consecutively.



## 8 Fuel pump (if present on the system)

Gen-set implements the full management of the fuel pump, to pump fuel from the storage tank to the tank on the generator. The pump can be managed automatically or manually using the controls on the front panel. Select function

### 8.1 Select function

With **MODE UP**  **Ref.1a** and **MODE DOWN**  **Ref.1a** buttons, select the **MAN, AUTO** or **TEST** mode. With the **UP**  and **DOWN**  navigation buttons, select the "STATUS (S.xx) Status information" menu, scroll the pages with the **LEFT**  and **RIGHT**  navigation buttons to page **S.10 FUEL PUMP**. From here you can use the standard setting procedure by pressing the **ACK/ENTER**  button to start (square brackets [xxxxxxx] flashing), and the **UP**  and **DOWN**  buttons to modify the command mode:

- **2-AUTOMATIC** (the pump is automatically activated when the low fuel level sensor intervenes and stops at the fuel maximum level)
- **1-MANUAL-ON** (pump active - the pump is activated when the fuel drops below the maximum level, and turns off when it exceeds it, keeping the level constant at all times).
- **0-MANUAL-OFF** (pump off)

Press **ACK/ENTER**  to confirm the mode.

 **INFORMATION!** : The second option (**MANUAL-ON**) can be disabled by the Gen-set control module in relation to the fuel level (the pump can not be started with a full tank).

*Warning: With the fuel pump warning active, the command mode is automatically set to "0-MANUAL-OFF".*





## MECC ALTE SPA (HQ)

Via Roma  
20 – 36051 Creazzo  
Vicenza – ITALY

T: +39 0444 396111  
F: +39 0444 396166  
E: info@meccalte.it  
aftersales@meccalte.it

## MECC ALTE PORTABLE

Via A. Volta  
137038 Soave  
Verona – ITALY

T: +39 0456 173411  
F: +39 0456 101880  
E: info@meccalte.it  
aftersales@meccalte.it

## MECC ALTE POWER PRODUCTS

Via Melaro  
2 – 36075 Montecchio  
Maggiore (VI) – ITALY

T: +39 0444 1831295  
F: +39 0444 1831306  
E: info@meccalte.it  
aftersales@meccalte.it

## ZANARDI ALTERNATORI

Via Dei Laghi  
48/B – 36077 Altavilla  
Vicenza – ITALY

T: +39 0444 370799  
F: +39 0444 370330  
E: info@zanardialternatori.it

## UNITED KINGDOM

Mecc Alte U.K. LTD  
6 Lands' End Way  
Oakham  
Rutland LE15 6RF

T: +44 (0) 1572 771160  
F: +44 (0) 1572 771161  
E: info@meccalte.co.uk  
aftersales@meccalte.co.uk

## SPAIN

Mecc Alte España S.A.  
C/ Rio Taibilla, 2  
Polig. Ind. Los Valeros  
03178 Benijofar (Alicante)

T: +34 (0) 96 6702152  
F: +34 (0) 96 6700103  
E: info@meccalte.es  
aftersales@meccalte.es

## CHINA

Mecc Alte Alternator (Nantong) Ltd  
755 Nanhai East Rd  
Jiangsu Nantong HEDZ 226100  
People's Republic of China

T: +86 (0) 513 82325758  
F: +86 (0) 513 82325768  
E: info@meccalte.cn  
aftersales@meccalte.cn

## INDIA

Mecc Alte India PVT LTD  
Plot NO: 1, Talegaon  
Dhamdhare S.O.  
Taluka: Shirur,  
District: Pune – 412208  
Maharashtra, India

T: +91 2137 673200  
F: +91 2137 673299  
E: info@meccalte.in  
aftersales@meccalte.in

## U.S.A. AND CANADA

Mecc Alte Inc.  
1229 Adams Drive  
McHenry, IL, 60051

T: +1 815 344 0530  
F: +1 815 344 0535  
E: info@meccalte.us  
aftersales@meccalte.us

## GERMANY

Mecc Alte Generatoren GmbH  
Bucher Hang 2  
D-87448 Waltenhofen

T: +49 (0)831 540755 0  
E: info@meccalte.de  
aftersales@meccalte.de

## AUSTRALIA

Mecc Alte Alternators PTY LTD  
10 Duncan Road, PO Box 1046  
Dry Creek, 5094, South  
Australia

T: +61 (0) 8 8349 8422  
F: +61 (0) 8 8349 8455  
E: info@meccalte.com.au  
aftersales@meccalte.com.au

## FRANCE

Mecc Alte International S.A.  
Z.E. la Gagnerie  
16330 St. Amant de Boixe

T: +33 (0) 545 397562  
F: +33 (0) 545 398820  
E: info@meccalte.fr  
aftersales@meccalte.fr

## FAR EAST

Mecc Alte (F.E.) PTE LTD  
10V Enterprise Road, Enterprise 10  
Singapore 627679

T: +65 62 657122  
F: +65 62 653991  
E: info@meccalte.com.sg  
aftersales@meccalte.com.sg



[www.meccalte.com](http://www.meccalte.com)

The world's largest independent  
producer of alternators 1 – 5,000kVA



File Name: EAAM045503EN.docx  
Rev. 04 Date: 04/09/2015  
Product: GC315xx-GC400xx